



Sistem bileşenleri

System components

Madde Article	Kapak kalınlığı Door Thickness (mm)	EB	Ürün Kodu Order Code	Birim PU	Paket Pack
2 kapak uygulama / For 2 door cabinets 	16 - 18 - 19 - 20	30	8220 SFT	1	6
	22 - 25 - 28	36	8230 SFT	1	6
	30 - 35	45	8235 SFT	1	6
	40 - 50	59	8250 SFT	1	6
3 kapak uygulaması Orta kapak sadece sağa veya sola açılabilir. For 3 door cabinets Centre door for opening only RIGHT or only LEFT 	16 - 18 - 19 - 20	30	8220 SFT 8200C	1 1	6 6
	22 - 25 - 28	36	8230 SFT 8200C	1 1	6 6
	30 - 35	45	8235 SFT 8200C	1 1	6 6
	40 - 50	59	8250 SFT 8200C	1 1	6 6

Profil setleri

Profile sets

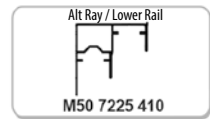
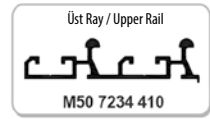
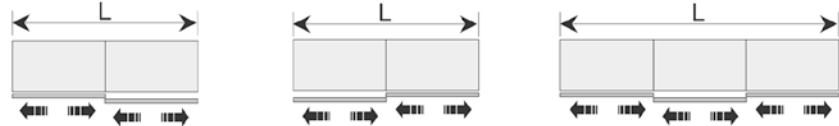

Madde Article	L (mt) Kabin Uzunluğu Cabinets length	Ürün Kodu Order Code	PU	Paket Pack
2 veya 3 kapaklı dolap için 2.00 mt. 2 or 3 door cabinets 2.00 mt	2.00	M50 7234 410		
	2.00	M50 7225 410		
2 veya 3 kapaklı dolap için 2.50 mt. 2 or 3 door cabinets 2.50 mt	2.50	M50 7234 410		
	2.50	M50 7225 410		
2 veya 3 kapaklı dolap için 3.00 mt. 2 or 3 door cabinets 3.00 mt	3.00	M50 7234 410		
	3.00	M50 7225 410		
2 veya 3 kapaklı dolap için 4.00 mt. 2 or 3 door cabinets 4.00 mt	4.00	M50 7234 410		
	4.00	M50 7225 410		



Planlama ölçüleri

Planning dimensions

Teknik detaylar

Technical details

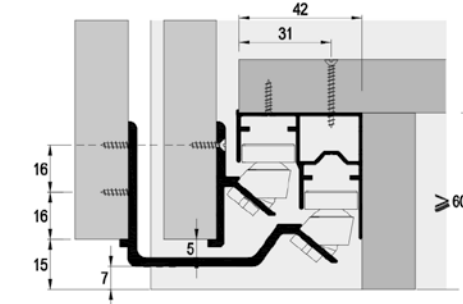
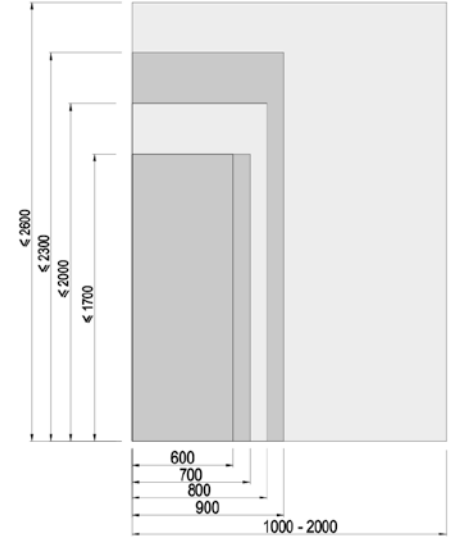
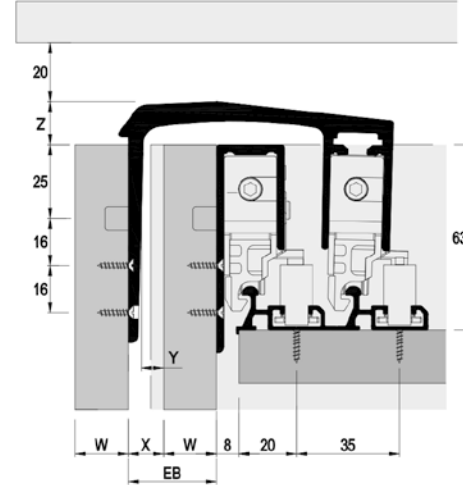

Kapak kalınlığı Door Thickness W (mm)	Ürün Kodu Code	EB	Kapaklar arasındaki mesafe Distance between doors		
			X	Y	Z
16	M02 8220 SFT	30	14	9	13
18	M02 8220 SFT	30	12	7	13
19	M02 8220 SFT	30	11	6	13
20	M02 8220 SFT	30	10	5	13
22	M02 8230 SFT	36	14	9	13
25	M02 8230 SFT	36	11	7	13
28	M02 8230 SFT	36	9	5	13
30	M02 8235 SFT	45	15	10	13
35	M02 8235 SFT	45	10	5	13
40	M02 8240 SFT	51	11	5	13
44	M02 8250 SFT	59	15	9	13
50	M02 8250 SFT	59	9	5	13

Bilgilendirme

Information

Üstten çalışan , ayarlanabilen sürme kapı sistemi	Two roller, top running Adjustable sliding door system
Her yöne yavaşlatıcı kullanılabilir	Able to use soft closing all sides
Birbiri üzerine sürülebilir kapı pozisyonu	Overlay door position
2-3-4 kapak kullanılabilir	Usable for 2 / 3 / 4 doors cabinets
Kapı ağırlığı 80 kg a kadar. Minimum kapı ağırlığı 25 kg	Door weight up to 80 kg Minimum door weight 25 kg
Kapı yüksekliği 2700 e kadar	Door height up to 2700 mm
Kapı genişliği 600-2000 mm arası	Door width 600 - 2000 mm
Kapı kalınlığı 16-18-19-20-22-25-28-40-50 mm	Door thicknesses 16 - 18 - 19 - 20 - 22 - 25 - 28 - 40 - 50 mm
Güvenli ray kilidi vardır	Safety with rail lock
Hızlı kurulum	Fast installation

PDF QR

VIDEO QR



* Verilen ölçüler bağlayıcı değildir. Önerilen kurulum ölçüleridir. Albatır ürün özelliklerinde haber vermeden değişiklik yapabilir.
* The given dimension are not binding. These are recommended asamble dimensions. Albatır can make alteration to product specification without notice.

* Verilen ölçüler bağlayıcı değildir. Önerilen kurulum ölçüleridir. Albatır ürün özelliklerinde haber vermeden değişiklik yapabilir.
* The given dimension are not binding. These are recommended asamble dimensions. Albatır can make alteration to product specification without notice.



Kapak açma seçenekleri

Door opening options

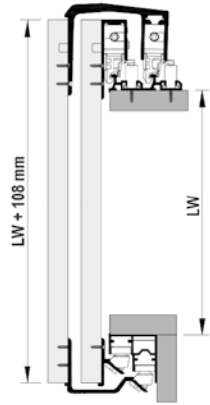
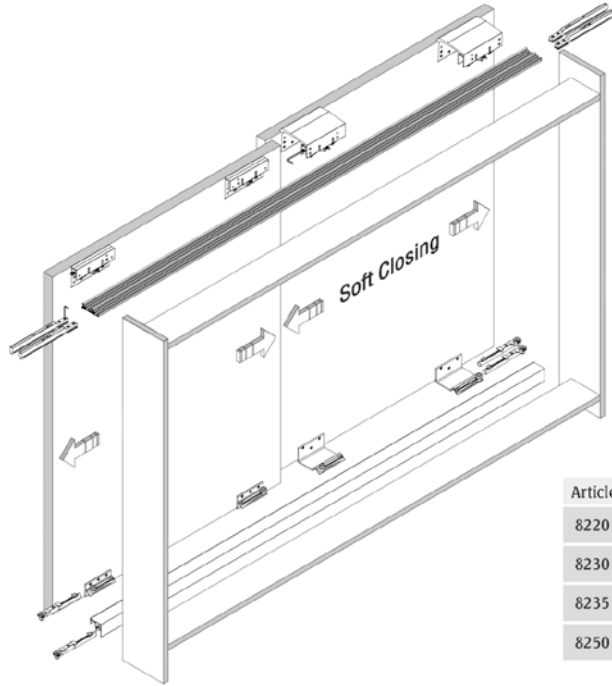

Article	EB	S	G
8220 SFT	30	< 350	33
8230 SFT	36	< 350	39
8235 SFT	45	< 350	48
8250 SFT	59	< 350	62

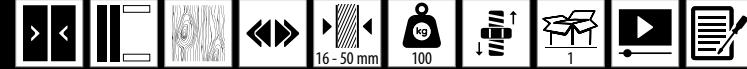

İç kapak için mekanizma montaj ölçüleri

Mechanism mounting dimensions / Internal door

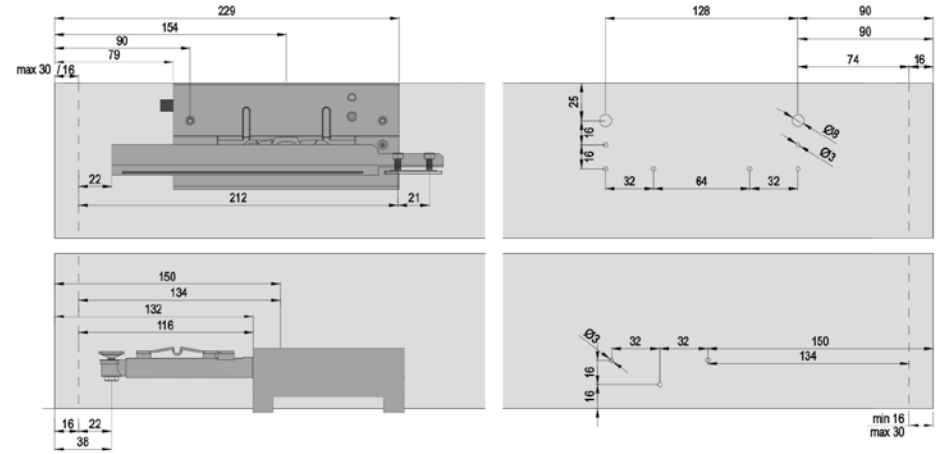

Dış kapak için mekanizma montaj ölçüleri

Mechanism mounting dimensions / External door

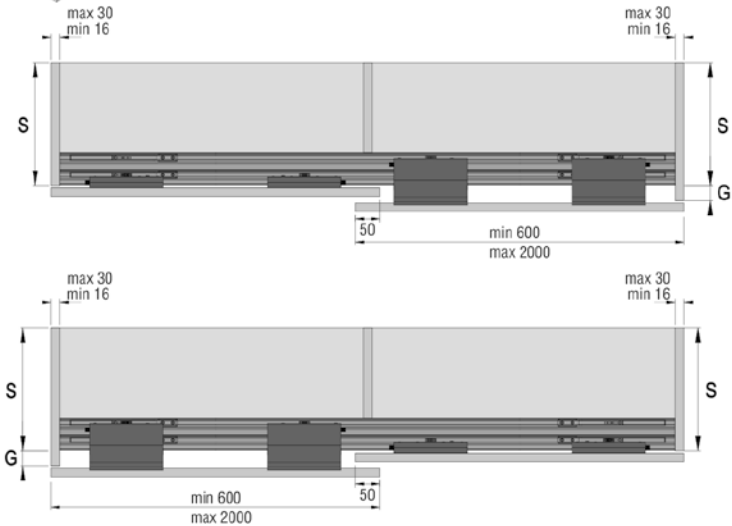
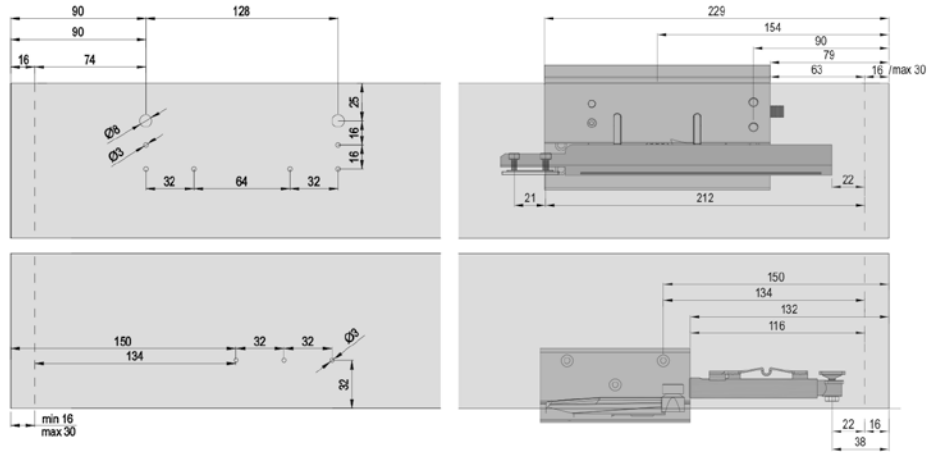

* Verilen ölçüler bağlayıcı değildir. Önerilen kurulum ölçüleridir. Albatür ürün özelliklerinde haber vermeden değişiklik yapabilir.
* The given dimension are not binding. These are recommended assemble dimensions. Albatür can make alteration to product specification without notice.

* Verilen ölçüler bağlayıcı değildir. Önerilen kurulum ölçüleridir. Albatür ürün özelliklerinde haber vermeden değişiklik yapabilir.
* The given dimension are not binding. These are recommended assemble dimensions. Albatür can make alteration to product specification without notice.

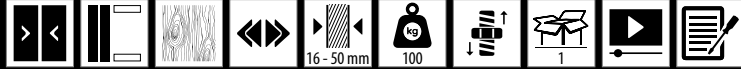

Kapak açma seçenekleri

Door opening options

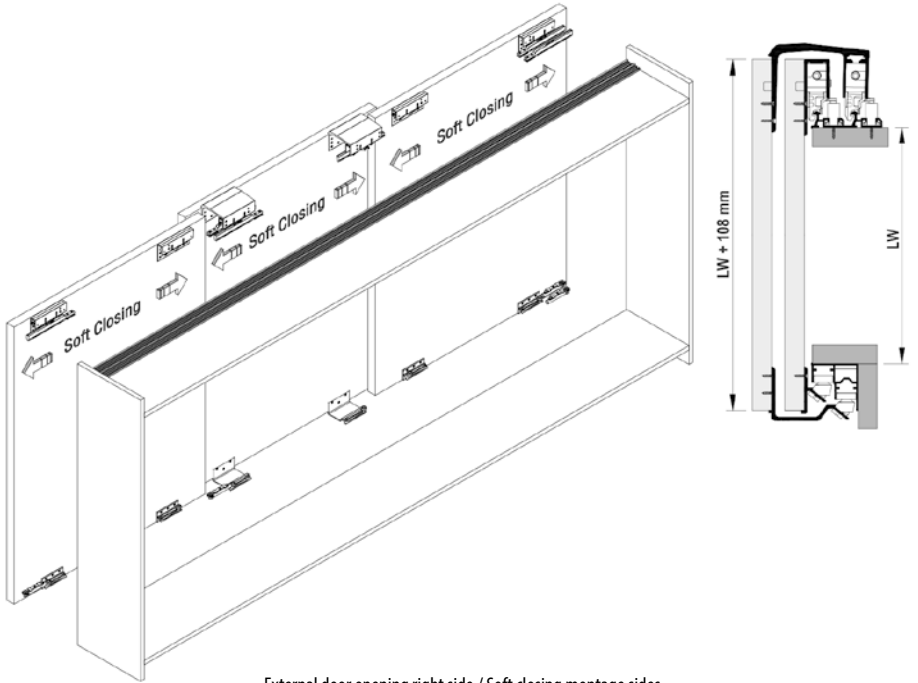

External door opening right side / Soft closing montage sides
Dış kapak sağ tarafa açılır / Yavaşlatıcı montaj yerleri

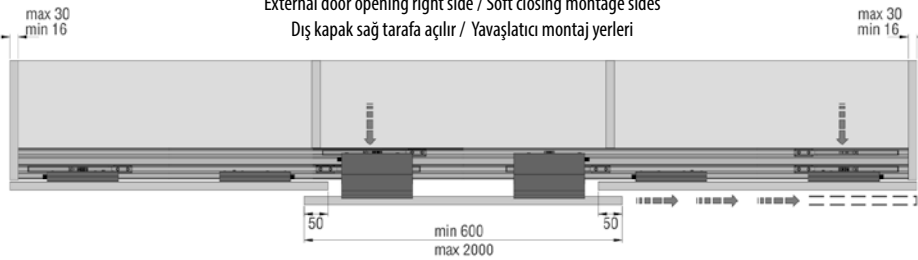

Montage sides of upper soft closing parts
Üst yavaşlatıcı montaj yerleri

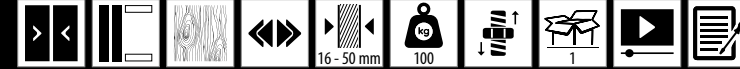

Door opening options

Door opening options

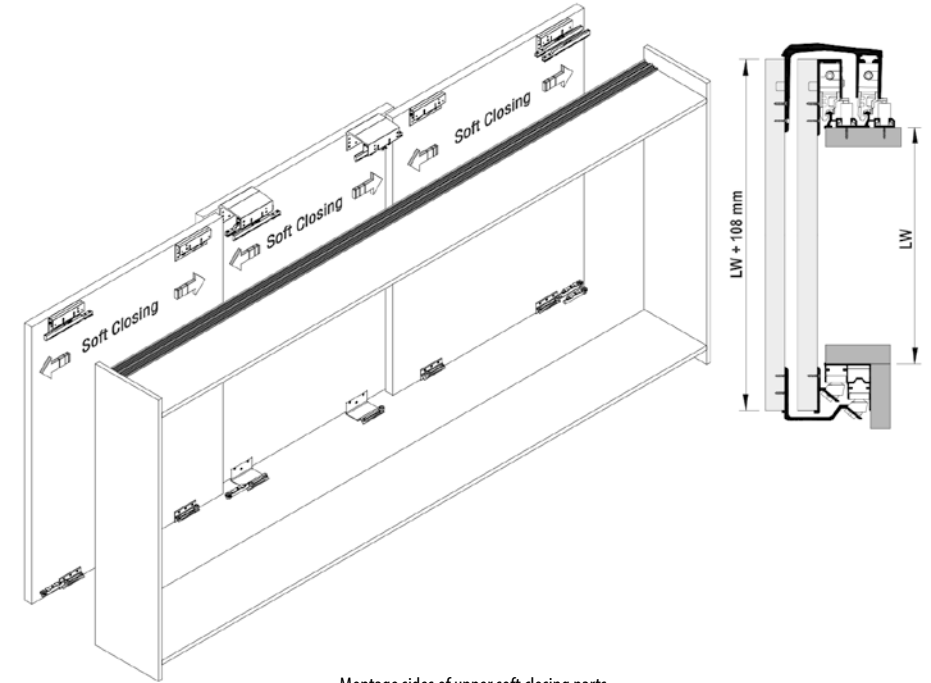

Montage sides of upper soft closing parts
Üst yavaşlatıcı montaj yerleri

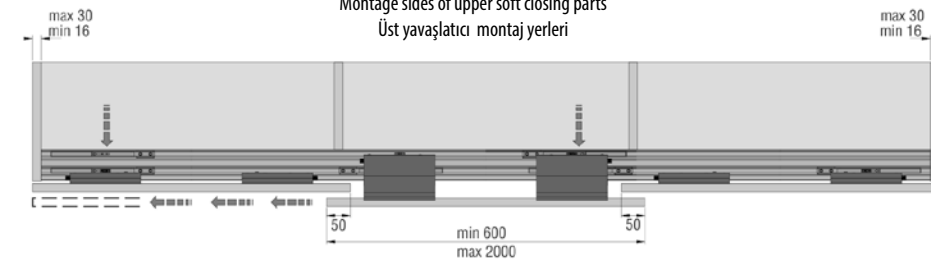

Montage sides of bottom soft closing parts
Alt yavaşlatıcı montaj yerleri



* Verilen ölçüler bağlayıcı değildir. Önerilen kurulum ölçüleridir. Albatür ürün özelliklerinde haber vermeden değişiklik yapabilir.
* The given dimension are not binding. These are recommended assemble dimensions. Albatür can make alteration to product specification without notice.

* Verilen ölçüler bağlayıcı değildir. Önerilen kurulum ölçüleridir. Albatür ürün özelliklerinde haber vermeden değişiklik yapabilir.
* The given dimension are not binding. These are recommended assemble dimensions. Albatür can make alteration to product specification without notice.



Kurulum

Installation

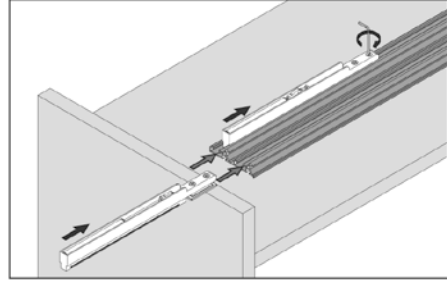

- 1- Üst yavaşlatıcı montajı
Installing upper dampers
2- Üst ray montajı
Installing running profile

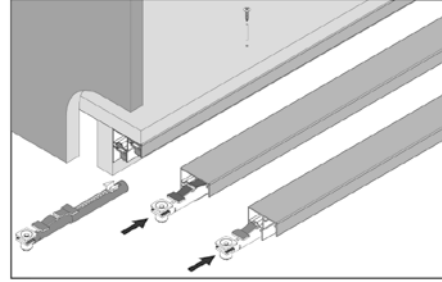
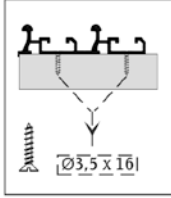

- 3- Alt yavaşlatıcı montajı
Installing bottom dampers
4- Alt ray montajı
Installing guiding profile

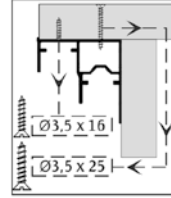

İç kapak

Internal door

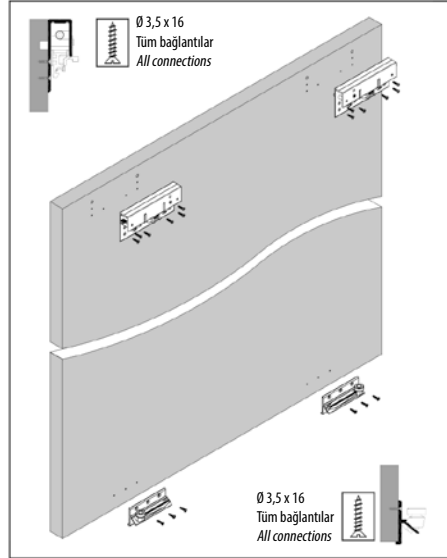

- 5- İç kapak ; üst ve alt mekanizmaların montajı
Internal door ; Installing Runnig and guiding components

Dış kapak

External door

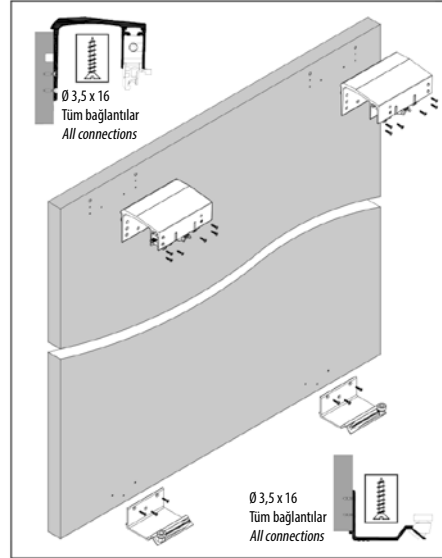

- 5- Dış kapak ; üst ve alt mekanizmaların montajı
External door ; Installing Runnig and guiding components

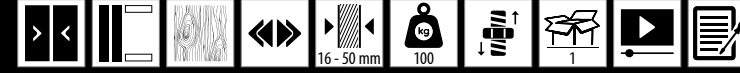

Kapak montaj seçenekleri

Door montage options

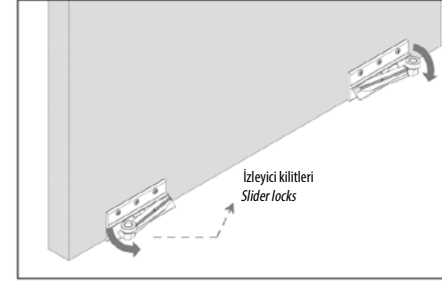

- 7- İlk olarak , iç kapak : alt izleyici kilitleri açılmalı
First of all , internal door :must open bottom slider locks

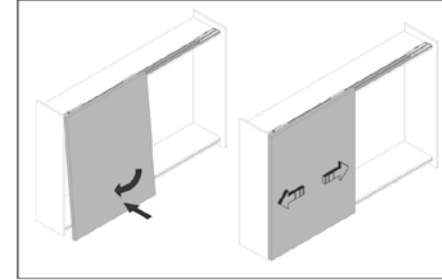

- 8- Üst tekerleri raya yerleştir , sonra kapağın altını iterek alt izleyicileri kilitle. Üst ve alt ray kilitleri otomatik olarak aktif olacaktır.
Put running rollers to upper rail after that push the bottom of door and lock the bottom slider upper and bottom rail locks will be activated automatically

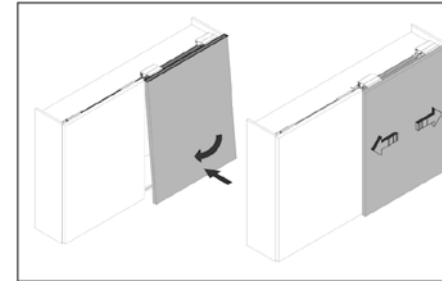

- 9- İkinci olarak , dış kapak : alt izleyici kilitleri açılmalı
Secondly , external door ; must open bottom slider locks

- 10-Üst tekerleri raya yerleştir , sonra kapağın altını iterek alt izleyicileri kilitle. Üst ve alt ray kilitleri otomatik olarak aktif olacaktır.
Put running rollers to upper rail after that push the bottom of door and lock the bottom slider upper and bottom rail locks will be activated automatically

- 11-Kapak yüksekliği ayarlama
Adjusting of door height

